

## Energy efficiency in machining production

### 02 | Energy efficiency



Prof. Dr.-Ing. Eckehard Kalhöfer | Dr. Jochen Kress

Energy is becoming ever more expensive. On the one hand, (conventional) energy reserves are dwindling without, up to now, a complete solution that permits adequate amounts of energy to be obtained cost-effectively from renewable forms of energy. On the other hand, production and commerce are not possible without energy. By increasing the energy efficiency of production processes, greater added value can be achieved with less energy usage.

In this paper the energy consumption of machine tools and the machining processes running on these machines are analysed. Effective, specific approaches for increasing energy efficiency are derived from this analysis with a focus on the optimisation of tools and machining processes.

**Motivation Motivation**

The usage of energy is essential for modern production and commerce. Global population growth, increasing quality of life and economic growth are the drivers continually increasing energy consumption. On the other hand, global energy consumption is limited by the restricted availability of energy sources such as coal, oil or even bio-fuels. Global warming and its consequences along with the pollution often linked with energy transformation also ultimately limit energy consumption. The increasing demand for energy within the current limits is resulting in increasing energy prices over the long term.

Against this background, the energy efficiency of production processes is a technology driver that will also make modern production possible in the future. But how and by making which specific changes can energy efficiency be increased in machining production?

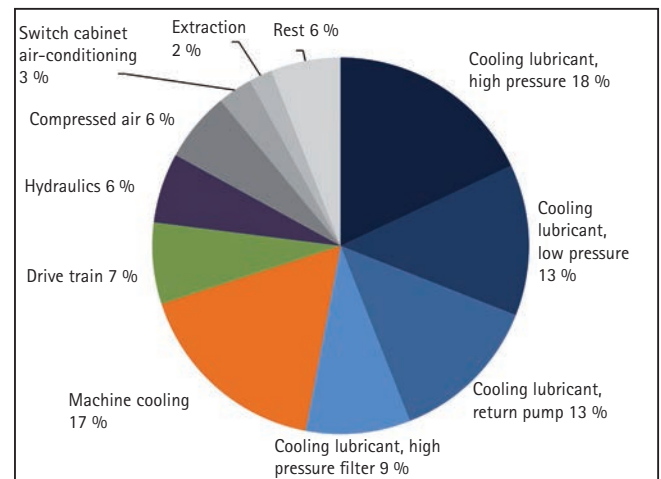

Figure 1: Breakdown of the energy consumption of the individual components of a machining centre. (MAG XS211) with 3-shift series production, from (1)

**INDEX**

Motivation	2
Potential savings	3
Energy-efficient machine tool	3
Energy efficiency optimised tools and machining processes	5
Energy savings	6
Summary	11

### Potential savings

#### Where is it possible to save energy during manufacture?

To address this question it must first be analysed which loads are relevant in modern machining manufacture. Obviously here the machine tool with its integrated, attached or central cooling lubricant system is the first point. Along with the machine tools there is a series of central systems that are necessary for production and that also consume energy. These „interdisciplinary technologies“ include, e.g., lighting, compressed air systems, heating and cooling systems, building ventilation, materials handling and the pumps and drives that are integrated into these technologies.

### The energy-efficient machine tool

These interdisciplinary technologies are to be found in numerous different forms of manufacturing. Optimisation potential found in these areas can be easily transferred to the specific manufacturing situation, independent of the range of parts produced. Effective measures, often with a short payback period, are the reduction of losses due to leaks in the compressed air system and the modernisation of the building lighting and the heating and cooling systems (2). Pumps and electric motors that run at constant power for a large part of the day should be replaced with modern, more energy-efficient components. Under these conditions - long running time at constant power output - the additional costs for electric motors of the highest energy efficiency class (IE3) will be recouped in less than 3 years.

If the energy consumption of the machine tool (including the cooling lubrication) is considered, various approaches for increasing the energy efficiency can be defined:

- The optimisation of the machine tool and its components in relation to energy consumption,
- The minimisation of the machine running time by shutting down during times when there is no production and
- The optimisation of the machining process and the tools used for the process.

#### The energy-efficient machine tool

The energy consumption of the actual production machines in predominantly large-scale series production machining typically represents around 80 % of the total energy consumption (3, 4). Figure 2 shows the typical distribution of the energy consumption on a machining centre for representative 3-shift production. The supply of cooling lubricant typically represents somewhat more than 50 % of this consumption. The machine cooling, the drive train and the hydraulics represent other major elements of the energy consumption. The energy consumption of cooling lubricant units can be reduced above all by provision of the cooling lubricant as needed - that is by means of speed-regulated pumps. In this way the energy consumption of the cooling lubricant unit can be reduced by 60 % in some cases (1). By this means the energy consump-

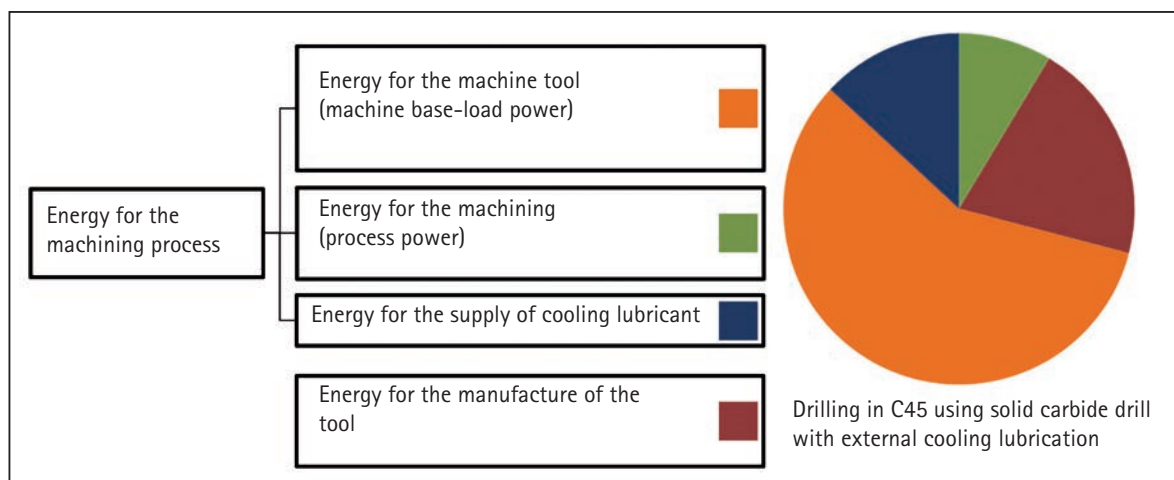

Figure 2: Example distribution of the energy required for a machining process.

### Energy-efficient machine tool

tion of the overall machine in this example can be reduced by 30 % simply by optimising the cooling lubrication.

A speed-regulated pump is also energy efficient for the machine's hydraulics or, if demand is low, a constant-speed pump together with an accumulator in accumulator charging mode. In the second case the hydraulic pump only runs from time to time to restore the pressure in the accumulator. In the meantime the demand for hydraulic oil is covered by the accumulator (5).

Machine tools for machining are typically productive for around one third or less of the time. The remaining machine running time is waiting time and time spent making settings and changing tools (6). This information results in two conclusions for energy efficiency. During these non-productive times, dispensable energy-consuming components should be shut down by automatic standby managers. By means of this measure, in some cases more than 20 % of the total energy of the machine tool can be saved (1).

In case of high requirements on precision, shutting down components can, however, result in major thermal deformation of the machine tool and as consequence out-of-tolerance results. It must therefore be checked in the specific case which components of the machine tool can be shut down during interruptions in production.

In addition, by means of organisational measures it should be attempted to reduce the non-productive times of the machine tools. This aspect will improve the productivity and cost-effectiveness of the entire production process and significantly reduce the energy consumption.

The energy saving potential addressed up to now can to some extent only be realised by purchasing new machine tools optimised for energy efficiency. In some cases it is also possible to retrofit existing components, e.g. to replace a constant-speed pump with a speed-regulated pump. Typically, energy-efficient machine components are expensive to procure, such that the user must decide whether the increased investment can be justified by the energy savings in operation.

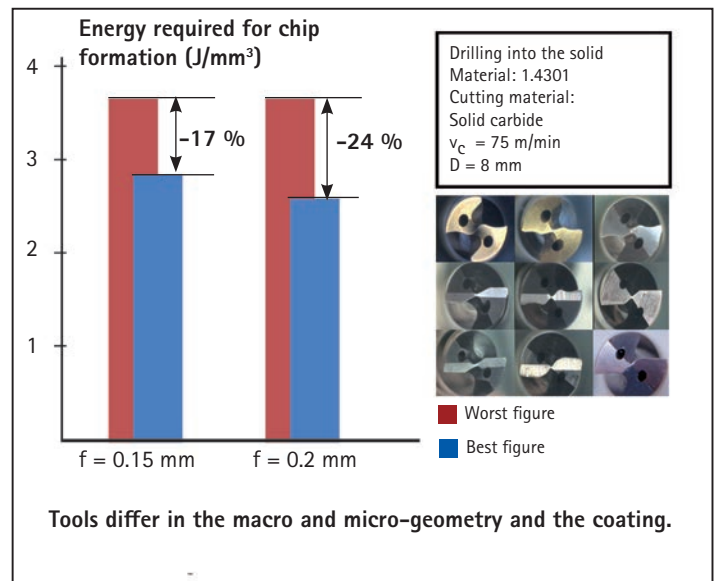

Figure 3: Reduction of the process energy by optimising the cutting edges.

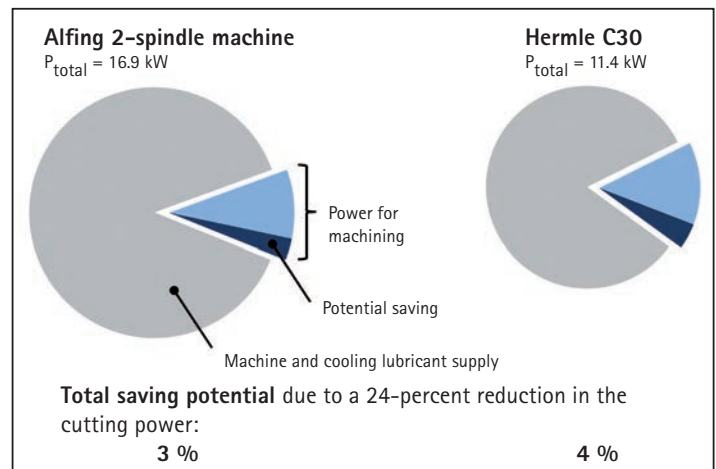

Figure 4: Total potential saving due to reducing the process energy.

The investment in a new, energy efficient machine tool is generally only worthwhile if replacement is necessary anyway.

In view of the large number of existing machine tools in Germany and the long service life of these machines, it is also necessary to check and realise the potential savings that can be achieved by means of tool and process optimisation.

### Energy efficiency optimised tools and machining processes

#### Energy efficiency optimised tools and machining processes

For the optimisation of the tool and process it is appropriate to structure of the energy consumption of a machine tool differently to that shown in figure 1. All the loads on the machine that run continuously or from time to time in the operational state are summarised in the following (figure 2). The power consumption of these loads is combined to form the base-load power of the machine. The power consumption of all loads related to the cooling lubrication is combined to form the cooling lubricant power. The additional power consumed by the machine tool during machining beyond the base-load power is termed the process power.

optimum at the user could involve extremely short tool lives that would result in high energy consumption at the tool manufacturer.

The portions of these four forms of energy of the total energy required depend, of course, heavily on the machine tool and the process. In the majority of the cases the process energy is however less than 20 % of the total energy. The cooling lubricant power can represent a significantly larger portion if high-pressure internal cooling lubrication is used. The portion of energy for tool manufacture can be significantly lower than shown in figure 2 on the usage of indexable inserts; Figure 2 is based on data measured on drilling a bore using a solid carbide drill.

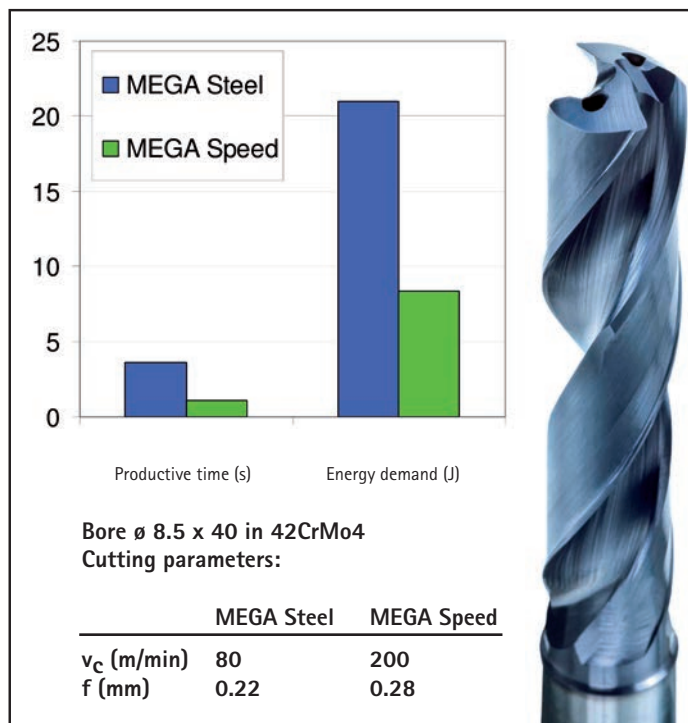

Figure 5: Saving productive time and energy by increasing productivity.

Multiplied by the running time, these powers give the related energy (process energy, cooling lubricant energy, energy for the machine tool). And finally, for holistic optimisation it is appropriate to take into consideration the energy consumed during the manufacture of the tools used for machining. If this aspect is not taken into account, the energetic

An apparently obvious approach for reducing the process energy is to use tools with a particularly light cut. Here the cutting force is comparatively low due to appropriate micro and macro-geometry (small cutting edge radii, large rake angles) and due to a low-friction coating. By means of these measures the necessary energy for chip formation and with it the cutting force can be significantly reduced. Drilling trials on stainless steel produced, in a benchmark with a total of nine solid carbide twist drills, differences in the cutting force and energy for chip formation of up to 24 % with the same productivity (figure 3). This 24 % potential saving, however, only reduces the total energy for the machining process by 3 to 4 % (figure 4). The basis for these figures is measurements on a typical machining centre for large-scale series production in the automotive industry (Alfing 2-spindle machine) and

another machining centre that is used for series production and also for tool and mould making (Hermle C30).



Energy efficiency optimised tools and machining processes



**Multi-tooth reamer**

Material: C70  
Bore:  $\varnothing$  58 mm H7  
Cutting material: Cermet  
Number of blades: 18

Cutting data:  
 $v_c = 160$  m/min,  
 $f = 1.5$  mm/rev  
Surface finish:  $R_z = 1,4$   $\mu$ m  
Circularity: 4  $\mu$ m

consumption. An example for drilling is shown in figure 5. By optimising the drilling tool it was possible to reduce the productive time by 70 % and reduce the energy demand during the productive time by 60 %. The most important change in the tool geometry was a different arrangement of the guiding chamfers such that the drill cannot jam in the existing bore. In addition, the

cutting material and also the coating were changed.

Figure 6: Multi-tooth reamer for increasing productivity and energy efficiency.

In the majority of cases a reduction in the cutting force with the same productivity only has little effect on the energy consumption. Only in the case of machining processes where the process energy represents a large portion of the total energy consumption – such as during heavy roughing – does the reduction of the cutting force with the same productivity produce a significant increase in energy efficiency. However, attention must be paid to adequate cutting stability and process reliability. Lower cutting forces by means of lower feeds or material removal rates are counter-productive in relation to energy efficiency. They increase the energy demand due to the then longer machining time.

A further possible way to increase the productivity and therefore the energy efficiency is to increase the feed per turn. During fine machining using multicut reamers, it is possible to use tools with almost no chip space, given suitable workpiece geometry. In this way the number of cutting edges can be significantly increased and therefore also the feed rate that can be realised. Figure 6 shows such a tool that is used for the fine machining of connecting rods.

Energy savings by increasing the productivity of machining processes

**Energy savings by increasing the productivity of machining processes**

The base-load power and with it the energy for the machine tool that is necessary for its operational state in general represent a relatively large portion of the total power or energy. As such the machine occupancy time has a relatively significant effect on the total energy. Both productive times and also non-productive times should be as low as possible for an energy-efficient process. Increasing productivity has also been an optimisation goal in machining for some time. In this area there is a series of effective measures for reducing the energy

Energy savings by increasing the productivity of machining processes

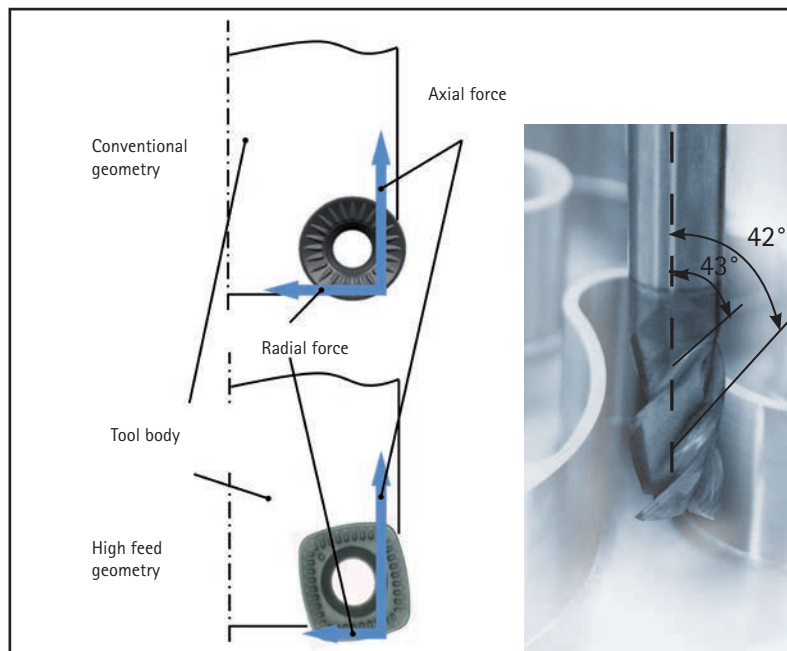

Figure 7: Tools with low tendency to chatter; on the left by means of lower radial force, on the right by means of different helix angles on the cutting edges.

Two examples of tools correspondingly optimised are shown in figure 7. On the right a tool is shown with cutting edges with different helix angles. In this way the individual frequencies are excited less, which results in less tendency to chatter and makes a higher material removal rate possible.

On the left of figure 7 the tool geometry for special high-feed milling cutters in comparison to conventional toric end milling cutters is sketched. These tools are often used in tool and mould making. The high-feed milling cutters are operated with very low axial material removal rates and

very high feeds; the active angles of these tools are very low. As a result the radial force on the tool is relatively low (and the axial force higher).

In many cases the productivity of a machining process is limited by the tool chattering. The tool and also the performance of the main spindle would permit higher productivity (a higher feed and/or a greater material removal rate). However, to prevent – self-excited – vibration through chattering, the feed and material removal rate must be limited. In such cases the productivity can be significantly increased if the tendency of the tool to chatter is reduced.

The tool is very stiff in the axial direction such that the higher axial force is not a problem. In the radial direction the tool is comparatively flexible. The smaller radial element of the total force with the small active angle makes it possible to realise very high feeds and a significantly higher material removal rate compared to toric end milling cutters and cylindrical milling cutters.

A good way to shorten significantly both the

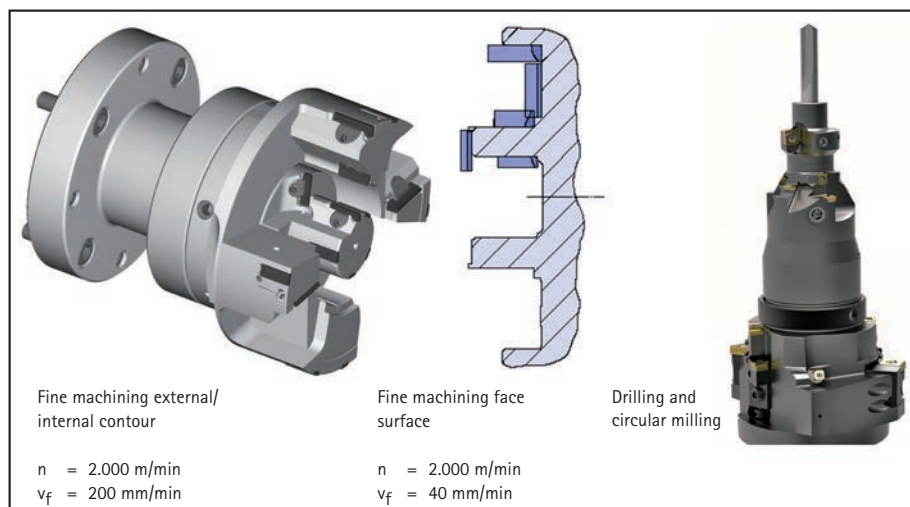

Figure 8: Combination tools for reducing productive and non-productive times.

Energy savings by increasing the productivity of machining processes

productive and non-productive times is offered by combination tools. In large-scale series production on machining centres, several machining operations can often be combined into one tool using combination tools. In this way on the one hand savings are made in the tool changing time and the energy consumption related to this time. On the other hand, the productive time is also significantly reduced by the simultaneous realisation of several machining tasks. Figure 8 on the left shows such a tool on which nine different machining steps have been combined into one tool. In some cases it is also possible to undertake different types of machining using a combination tool. A tool that is initially used for drilling and then for circular milling is shown in figure 8 on the right.

Energy savings due to minimum quantity lubrication

### Energy savings due to minimum quantity lubrication

As already clearly shown in figure 1, the energy consumption due to the cooling lubrication is very high. To make clear the potential for saving energy by using minimum quantity lubrication, measurements and analyses on two different machining centres are shown in the following. On the one hand, on the removal of the cooling lubricant system the energy consumption for this equipment is saved. On the other hand, compressed air is consumed for the minimum quantity lubrication; the production of compressed air is relatively energy-intensive. This compressed air consumption must be taken into account for the correct estimation of the savings.

First the conditions during drilling on an independently supplied machining centre are shown. Drilling is the most common machining process on machining centres and is therefore of particular relevance. The machine studied, a Hermle C30, has an average power consumption of approx. 5 kW during the machining process under consideration. The cooling lubricant unit has an additional power consumption of 5.5 kW in case of cooling lubrication through the tool at a pressure of 40 bar. Figure 9 shows the distribution of the power consumption during the drilling process with high pressure cooling lubrication through the tool, with minimum quantity lubrication through the tool and, for comparison, for completely dry machining. For consideration of the energy consumption, the compressed air consumption must be converted into an equivalent energy consumption. In (7) an electrical power

requirement of 6.5 to 7.5 kW per m<sup>3</sup>/min volumetric flow rate at a pressure of 6 bar was determined for very efficient compressed air systems. The information in figure 9 is based on 7 kW per m<sup>3</sup>/min. Losses due to leaks of 36 % as also determined in (7) were also taken into account.

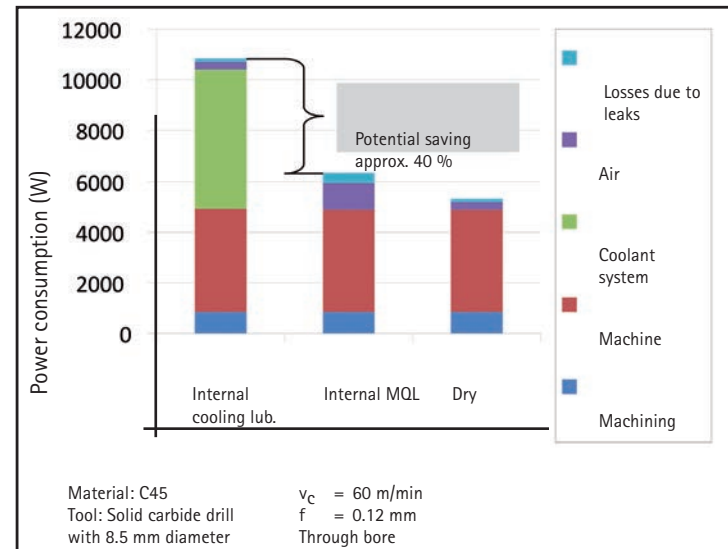

Figure 9: Potential saving due to minimum quantity lubrication on a machining centre with decentral cooling lubricant supply.

The measured results show significantly increased compressed air consumption with minimum quantity lubrication compared to conventional cooling lubrication through the tool. However, the energy required for the compressed air is significantly less than that required for conventional cooling lubrication. In total, minimum quantity lubrication reduces the energy required by around 40 % compared to high-pressure cooling lubricant supply (8).



Energy savings due to minimum quantity lubrication

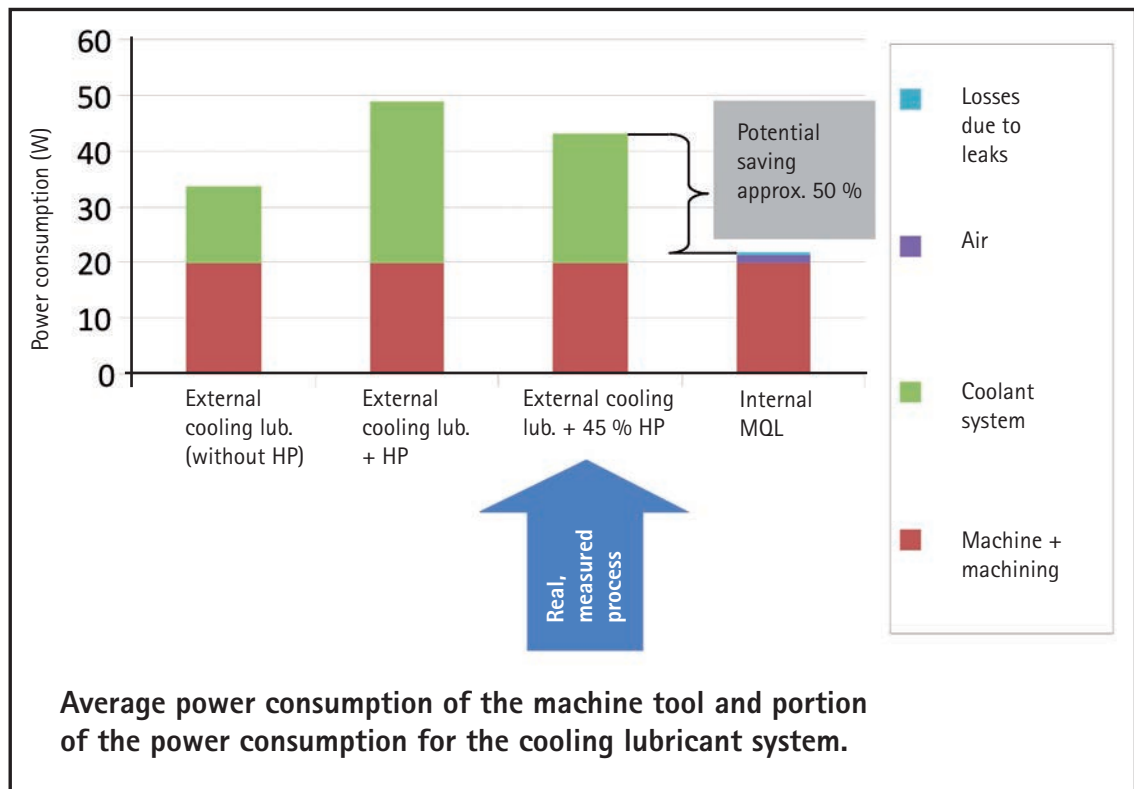

Figure 10: Potential saving due to minimum quantity lubrication on a machining centre with central cooling lubricant supply.

In large-scale series production, large central systems are often used for filtering and supplying the cooling lubricant. To reliably flush the chips off the workpiece and out of the machine compartment, high cooling lubricant volumetric flow rates are often used. The longer path between the central system and machine tool and the larger amounts of cooling lubricant result in an increased energy requirement for the cooling lubricant system than for independently supplied systems. This issue is reflected in the results shown in figure 10. It is based on measurements in large-scale series production in which a housing made of cast iron is machined using 15 machining centres.

The machines have an average power consumption of almost 20 kW during this machining (not including cooling lubricant-related components). The central system has a volumetric flow rate of 5000 l/min and a power consumption of 136 kW. High-pressure pumps and return pumps are also used on the machining centres. The high-pressure

cooling lubricant is used for 45 % of the machining time. Flushing with cooling lubricant is also in use during the entire machining time (low-pressure). The average power for the machine and (partially used) cooling lubricant system of some 43 kW can be reduced by around half by using minimum quantity lubrication.

This 50 % potential saving is however, not, completely realisable. On the usage of minimum quantity lubrication, a different system must be installed for the removal of the chips from the machine. If individual chip trucks at the machine are not possible, the chips can be removed, e.g., relatively energy-efficiently from the machine using suction systems. The systems available for this task can serve a larger number of extraction points/machines. The chips are not extracted continuously. After a certain amount of time the chips produced up to that time are extracted in a short burst and separated from the extraction air using a cyclone.

Energy savings due to minimum quantity lubrication



Figure 11: Twist drills with steel shank and carbide tip.

Energy consumed during manufacture

#### Taking into account the energy consumed during the manufacture of the tools

For holistic optimisation, along with the energy consumption at the user, the energy used to manufacture the machining tools must be taken into account. In many cases the user of the tools will not be interested in this aspect. However, with increasing energy costs energy-intensive tools will become over-proportionally expensive. To determine the total energy for the manufacture of products, the energy used to manufacture intermediate products and tools is also required.

For example, measurements on the manufacture of indexable inserts CNMA 120412 with a mass of 10 g that are not precision ground indicate an energy consumption of around 870 kJ. In the case of ground indexable inserts of the same size the energy consumed is increased by around 50 % due to the grinding (9).

Solid carbide tools such as twist drills or end milling cutters require significantly more energy during manufacture. The energy required for tools can be reduced, e.g., if as little carbide as possible is used. The replacement of a solid carbide drill with a drilling tool with a steel shank and solid carbide tip (figure 11) can reduce the energy required to manufacture the tool - referred to one bore - by around 28 % (10).

### Summary

### Summary

Today energy efficiency is of interest for a whole series of organisations and helps to reduce their energy costs (and total costs). In future this topic will become important for more and more manufacturing organisations as energy costs increase. During machining there are many approaches to improving energy efficiency. For interdisciplinary technologies such as pumps, electric motors, compressed air systems or lighting, an improvement in a wide range of areas of manufacturing can be achieved with comparatively little engineering effort.

Above all, if new investments are to be made in machine tools, there is large potential for savings within the machine. This statement applies above all to the cooling lubricant supply, the machine cooling and the hydraulics on the machines. Here consideration of the total costs (life cycle costs) helps to justify somewhat more expensive technology that can however save significant energy in operation. Organisational measures that result in a reduction of the non-productive times also improve energy efficiency in manufacturing.

Machine tools have a long service life such that an improvement in the energy efficiency for the operation of existing machines is also desirable. There are also approaches here to reduce the energy consumption. The reduction of productive and non-productive times for manufacturing processes is often particularly effective; along with an improvement in the energy efficiency this measure also of course reduces the machine costs. The usage of minimum quantity lubrication instead of conventional cooling lubrication also significantly reduces the energy required for manufacturing. If not only the energy required at the organisation undertaking the machining but also the energy for tool manufacture is taken into account, there are several possible ways to reduce the total energy required for machining by optimising the energy consumed during manufacture. If the energy consumption of the machine tool including the supply of cooling lubricant and compressed air is considered, often energy savings of more than 25 % can be achieved even with existing machine tools by means of comparatively low investments in optimised tools.

### Bibliography

1. Rothenbücher, S., Kuhrke, B.: Trendbericht: Energiekosten bei spanenden Werkzeugmaschinen, Werkstatt und Betrieb (2010) 9, S. 130-137
2. Heinen, T., Wulf, S.: Mehr Energieeffizienz in Fabriken, ZWF Zeitschrift für wirtschaftlichen Fabrikbetrieb 106 (2011) 7-8, S. 502-505
3. Sextl, A.: Nachhaltiges Energiemanagement in der BMW Group am Beispiel Produktion Fahrwerks- und Antriebskomponenten, Vortrag/Tagungsband Energieeffiziente Werkzeugmaschine, Düsseldorf, 24.02.2010
4. Mussa, S., Tilch, D.: Energieeffiziente Werkzeugmaschine – Systematik und praktische Umsetzung, Vortrag/Tagungsband Energieeffiziente Werkzeugmaschine, Düsseldorf, 24.02.2010
5. Abele, E., Sielaff, T., Beck, M.: Konfiguration energieeffizienter Werkzeugmaschinen, wt Werkstattstechnik online 102 (2012) 5, S. 292-298
6. Neugebauer, H., Westkämper, E., Klocke, F., Kuhn, A., Schenk, M., Michaelis, A., Spath, D., Weidner, E.: Abschlussbericht – Untersuchung zur Energieeffizienz in der Produktion. Fraunhofer-Gesellschaft zur Förderung der angewandten Forschung e.V., Chemnitz, 2008
7. Bayrisches Landesamt für Umweltschutz: Effiziente Druckluftsysteme, Senter Druck, Augsburg, 2004
8. Rief, M., Kalhöfer, E., Karpuschewski, B.: Energiebeitrag verschiedener Kühlschmiersysteme, Werkstatt und Betrieb (2010) 9, S. 142-145
9. Karpuschewski, B., Kalhöfer, E., Joswig, D., Rief, M.: Energiebedarf bei der Herstellung von Hartmetall-Wendeschneidplatten, ZWF Zeitschrift für wirtschaftlichen Fabrikbetrieb 106 (2011) 9, S. 602-605
10. Karpuschewski, B., Kalhöfer, E., Rief, M.: Energiebilanz einer Zerspanungsaufgabe, VDI-Z Spezial Werkzeuge (2012) 5, S. 50-52

### Prof. Dr.-Ing. Eckehard Kalhöfer

is the holder of the Chair for Machining at Aalen University.

[eckehard.kalhoefer@htw-aalen.de](mailto:eckehard.kalhoefer@htw-aalen.de)

**Dr. Jochen Kress** is a member of the senior management at MAPAL Dr. Kress KG.

[jochen.kress@de.mapal.com](mailto:jochen.kress@de.mapal.com)

**INFO: [www.mapal.com](http://www.mapal.com)**

You will find further information in this topic on our homepage or please request detailed documentation from:

[info@de.mapal.com](mailto:info@de.mapal.com)

MAPAL Präzisionswerkzeuge Dr. Kress KG  
Obere Bahnstraße 13 | 73431 Aalen  
Phone +49 7361 585-0  
Fax +49 7361 585-150



MAPAL Dr. Kress KG  
Obere Bahnstraße 13 | 73431 Aalen  
Phone +49 7361 585-0 | Fax +49 7361 585-150  
info@de.mapal.com      www.mapal.com